



Carax

THE MULTITRANSPORTER FOR PROFESSIONALS



MULTIPURPOSE TRAILERS **CARAX**

MULTIPURPOSE TRAILERS



PLANT TRAILERS



FLATBED TRAILERS





**ONLY THE BEST QUALITY
FOR MY COMPANY**

Carax, multipurpose trailer for intensive use

The Carax is a multipurpose trailer for professionals who wants to transport large vehicles like vans and SUVs. The Carax is available in the weight class of 3000 or 3500 kg, tandem or tridem and a loading floor dimension of 440x207 cm or 540x207 cm. The steel ramps with a length of 250 cm are stored in the chassis. This strong chassis provides optimum floor support for the aluminium loading floor.

The Carax multipurpose trailer is 100% wood-free and low-maintenance!



The Carax is available as tandem and tridem version

Everything a car transporter needs

The sophisticated design makes the Carax user-friendly. The most striking Carax detail is the fold at the rear of the loading floor. This allows longer vehicles to load and unload without any problem. Wheel stops and lashing straps are easy to mount through the specially designated recesses. The Carax is equipped with clear front, side and rear lights and LED contour lights. All Hulco Carax models are fitted with A-quality axles, clutch and overrun brake.



LED marker lights at the front

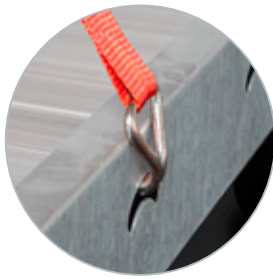

Recesses for tie-down possibilities



Steel ramps (250 cm) included



Lowered load floor at rear



Position lights (LED) included

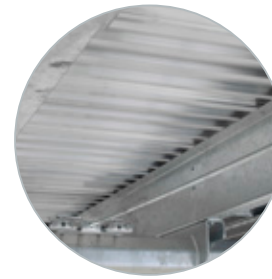

Strong chassis and maximum floor support



Integrated marker lights (LED) at the sides

Premium brake system



Channel for ramps

Suitable for large vehicles



Automatic jockey wheel

Long A-frame made out of tube-profile

Robust robot welded chassis

Recesses for straps

Premium quality axles and wheels

Integrated markerlights (LED)

LED position lights



Carax accessories

The Carax can be extended with a winch and support. The winch can be positioned on both the left and right position and is adjustable in length.

For securing a vehicle on the Carax, Hulco offers a complete system with wheel stops and Easyfix straps.

If you want more driving comfort, mounting shock absorbers is an option. This is recommended for intensive use of the Carax.

THE CARAX CAN HANDLE ALL VEHICLES

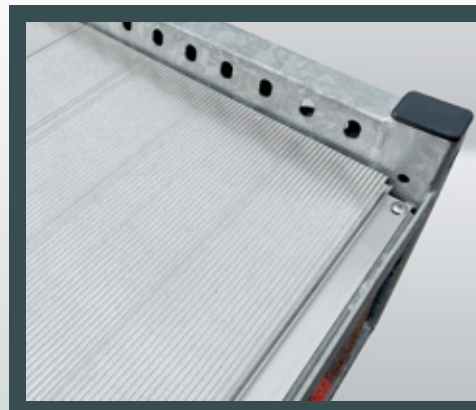

The strong aluminium loading floor with its optimum grip and support can carry a lot of weight. The loading floor has a channel at the front and rear for the ramps.

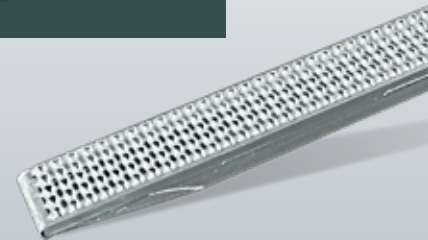
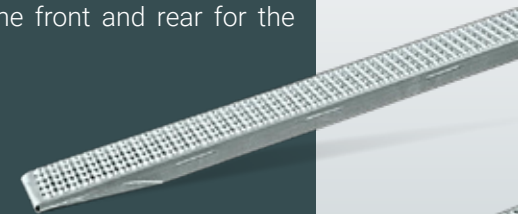



Accessorie:
Easyfix straps



Accessorie: A foldable
jockey wheel makes a
drive-through possible



Accessorie:
Propstands,
in one-hand useage



Accessorie: Adjustable
winch support for left- and
righthand use



Accessorie:
Axle shock absorbers
for extra comfort



Accessorie:
Spare wheel
with support



Accessorie:
Wheelstop



Lowered load floor
at the rear for easy
access

High grip
aluminium floor

Rotatable
winch

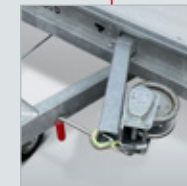

Hulco support

Hulco has an extended network of certified Hulco dealers! Please get informed ad your local Hulco dealer or www.Hulco.eu. The Hulco-dealer can help you to configurate your perfect Carax that 100% meeds your needs!





Type	Carax-2 3000 440x207	Carax-2 3000 540x207	Carax-2 3500 440x207	Carax-2 3500 540x207	Carax-3 3500 440x207	Carax-3 3500 540x207
Gross capacity	3000 kg	3000 kg	3500 kg	3500 kg	3500 kg	3500 kg
Axles pcs	2	2	2	2	3	3
Braked or unbraked version	braked	braked	braked	braked	braked	braked
Unladen trailer weight	690 kg	750 kg	735 kg	795 kg	785 kg	845 kg
Load capacity	2310 kg	2250 kg	2765 kg	2705 kg	2715 kg	2655 kg
Internal length (A)	440 cm	540 cm	440 cm	540 cm	440 cm	540 cm
Internal width (B)	207 cm	207 cm	207 cm	207 cm	207 cm	207 cm
Floor height rear (C1)	56 cm	56 cm	57 cm	57 cm	56 cm	56 cm
Floor height front (C2)	62 cm	62 cm	63 cm	63 cm	62 cm	62 cm
A-Frame length (D)	145 cm	145 cm	145 cm	145 cm	145 cm	145 cm
Total length (E)	590 cm	690 cm	590 cm	690 cm	590 cm	690 cm
Total width (F)	215 cm	215 cm	215 cm	215 cm	215 cm	215 cm
Ramp length (G)	250 cm	250 cm	250 cm	250 cm	250 cm	250 cm
Internal height (H)	4,5 cm	4,5 cm	4,5 cm	4,5 cm	4,5 cm	4,5 cm
Ramp width (I)	30 cm	30 cm	30 cm	30 cm	30 cm	30 cm
Wheel / tyresize	195/50R13	195/50R13	195/50R13	195/50R13	195/50R13	195/50R13

Accessories	Carax-2 3000 440x207	Carax-2 3000 540x207	Carax-2 3500 440x207	Carax-2 3500 540x207	Carax-3 3500 440x207	Carax-3 3500 540x207
Spare wheel with support	v	v	v	v	v	v
Propstands	v	v	v	v	v	v
Axle shock absorber	v	v	v	v	v	v
Winch with winch holder	v	v	v	v	v	v
Zijmarkeringsverlichting LED	s	s	s	s	s	s
Position lights (LED)	s	s	s	s	s	s
Strap set / Tie down wheel straps	v	v	v	v	v	v

s standard equipment

v deliverable as option

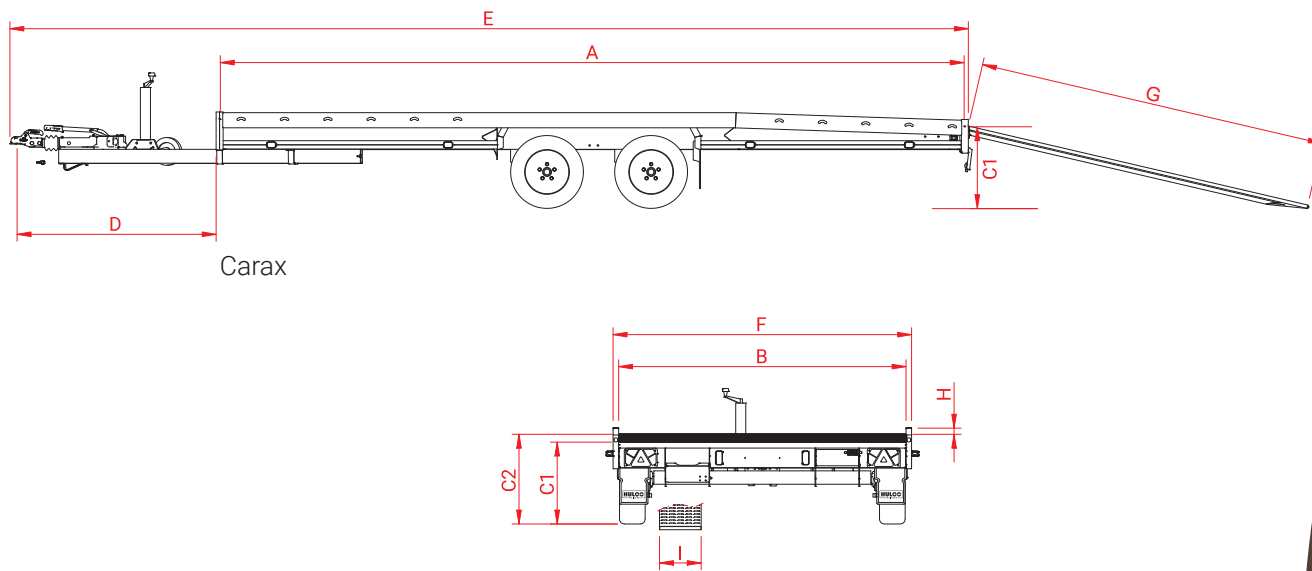

Carax

CHOOSE CARAX FOR RELIABLE VEHICLE TRANSPORT



Hulco Trailers, for professionals who set requirements

Since 2003 Hulco is developing trailers for the professional market. Thanks to incompany development, innovations and full automated production processes, a high quality level is always guaranteed. Hulco is one of the leading trailer producers in the European market.

Visit: www.hulco.eu



A Low loader trailers **BSX**



A Low loader trailers **GT-O**



A Low loader trailers **GT-R**



A Flatbed trailers **ASX**
(Incl. ramps)



A Flatbed trailers **PSX**



H Flatbed trailers **MEDAX**



A Flatbed trailers **PLT**



H Multipurpose trailers
CARAX



A Multipurpose trailers
MSX-Basic / MSX



A Car transporters
AMT



A Car transporters
AMT-ECO



A 3-way tipping trailers
KSX



A Backwards tipping trailers
KLT



A Hard top cover trailers
GT-HT / GT-VT1



A Box van trailers
GT-VT2 / GT-VT3 / GT-VT4



Your Hulco dealer



H Plant trailers
TERRAX



H Plant trailers
TERRAX



A Horse trailers **PTH**



A Construction trailers **PTS**



Wide range of accessories

HB2101EN-CAR

The Anssems Group:

Hulco Trailers GmbH
Wiener Straße 34
D-48455 Bad Bentheim-Gildehaus

Anssems Aanhangwagens B.V.
Ericssonstraat 50
NL-5121 ML Rijen

Anssems Anhänger GmbH
Londoner Straße 15
D-48455 Bad Bentheim-Gildehaus

Anssems Remorques Sarl
Rue Pierre Brossolette
FR-58600 Garchizy

